

---

# ASSEMBLY AND CARE INSTRUCTION

Dog Crate

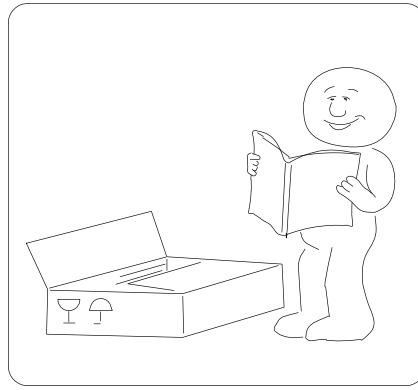
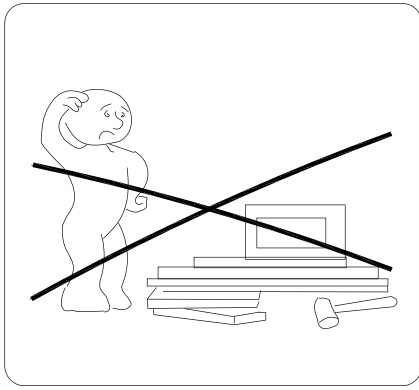

## **WARNING**

1. PLEASE READ ALL INSTRUCTIONS CAREFULLY BEFORE STARTING ASSEMBLY.
2. DO NOT LET ANY SHARP OBJECTS TOUCH OR RUB THE SURFACE OF THE PRODUCT.
3. WHEN ASSEMBLING, DO NOT LET CHILDREN PLAY AROUND THE WORKING AREA.
4. PLEASE CONFIRM ALL PARTS ARE CORRECT BEFORE STARTING THE ASSEMBLY PROCESS.
5. DO NOT TIGHTEN ALL BOLTS AND SCREWS COMPLETELY UNTIL THE ENTIRE UNIT HAS BEEN ASSEMBLED AND SET UP.

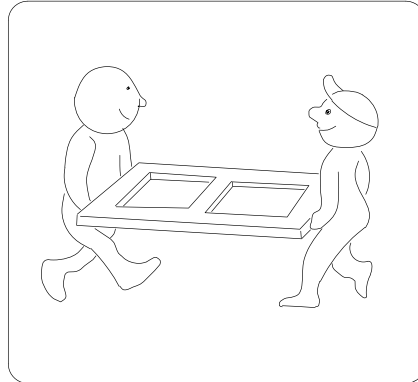
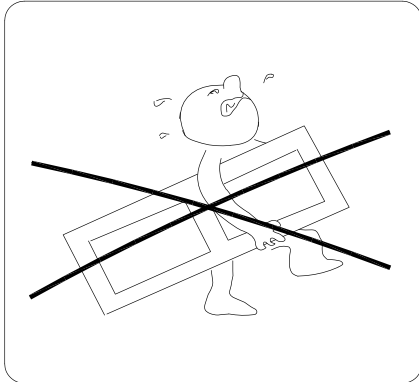
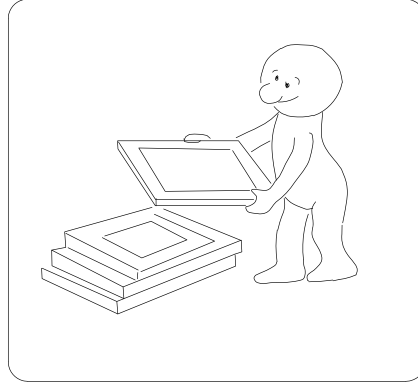
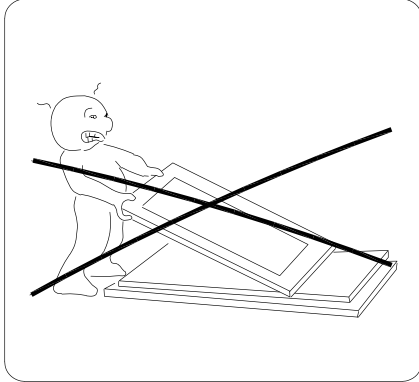

## ADVISE

1. DO NOT SIT OR STAND ON THIS PRODUCT. IT IS INTENDED FOR PETS ONLY.
2. THIS PRODUCT SHOULD BE ASSEMBLED BY AN ADULT.
3. PLEASE PUT THE PRODUCT ON A SMOOTH SURFACE AFTER YOU ASSEMBLED IT.
4. PLACE ALL PARTS ON A CLEAN AND SMOOTH SURFACE SUCH AS A RUG OR CARPET TO AVOID THE PARTS FROM BEING SCRATCHED.
5. THE SCREW OF HINGE ON THE DOOR ALSO CAN BE ADJUSTABLE, TO MAKE IT EVEN THEN TIGHTEN ALL SCREWS.

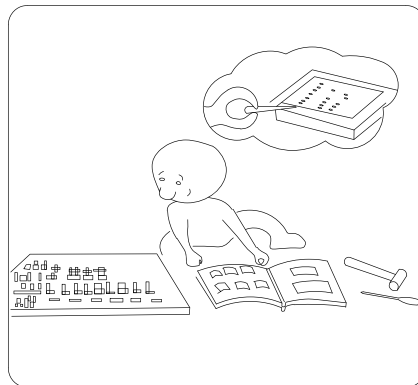
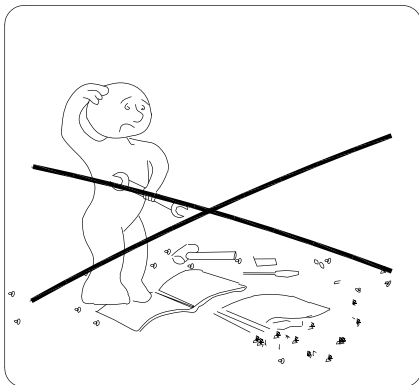

## TOOL NEEDED

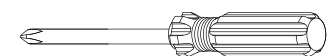

**SCREWDRIVER REQUIRED**  
- NOT INCLUDED

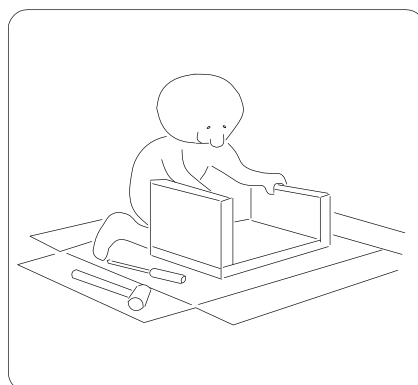

**PARTS**

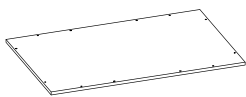
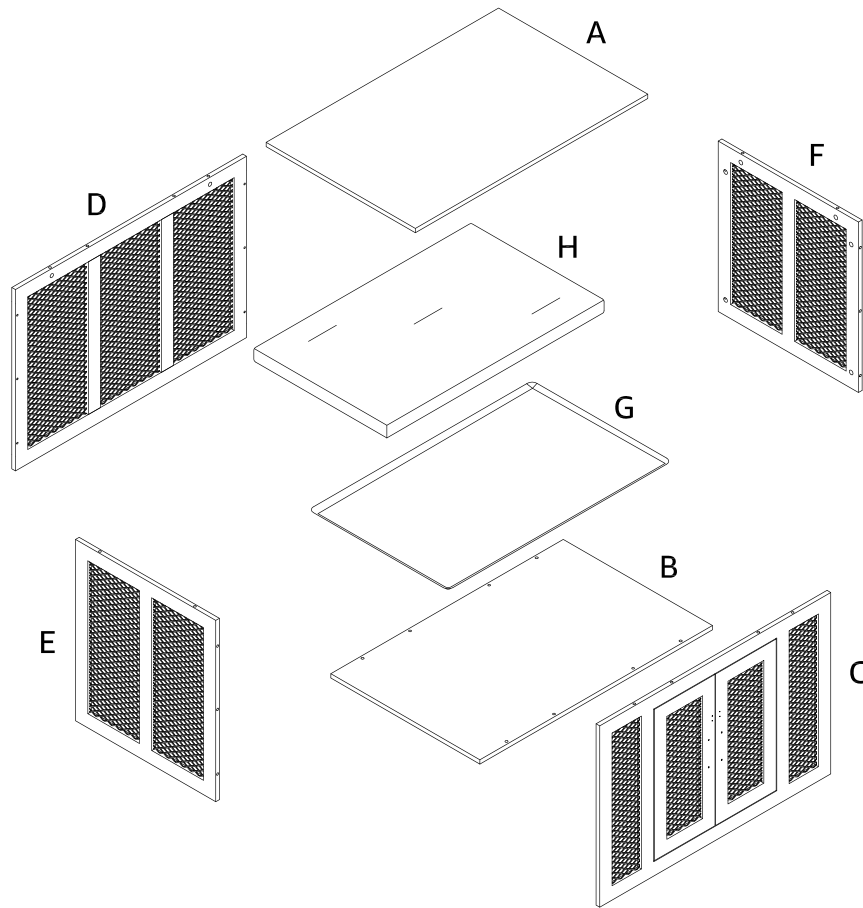

**A**  
Top Panel  
x1

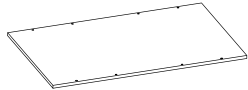

**B**  
Bottom Panel  
x1

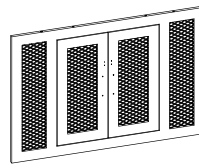

**C**  
Front Panel  
x1

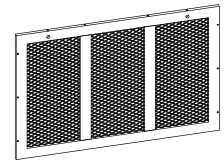

**D**  
Back Panel  
x1

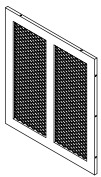

**E**  
Left Panel  
x1

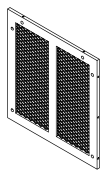

**F**  
Right Panel  
x1





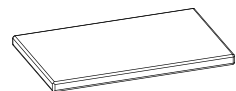







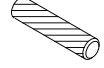

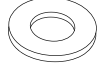
**G**  
Plastic Tray  
x1



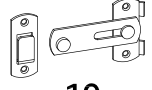

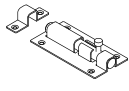

**H**  
Cushion  
x1

# HARDWARE

- |   |   |   |   |  |   |   |
|---|---|---|---|--|---|---|
|  |  |  |  |  |  |  |
| <b>1</b>  | <b>2</b>  | <b>3</b>  | <b>4</b>  | <b>5</b>   | <b>6</b>  | <b>7</b>  |
| x 16 pcs  | x 16 pcs  | x 12 pcs  | x 4 pcs   | x 4 pcs  | x 4 pcs   | x 1 pc  |
- 
- |   |   |   |   |  |   |
|---|---|---|---|--|---|
|  |  |  |  |  |  |
| <b>8</b>  | <b>9</b>  | <b>10</b>   | <b>11</b>   | <b>12</b>  | <b>13</b>   |
| x 2 pcs   | x 4 pcs   | x 1 set   | x 4 pcs   | x 2 sets   | x 12 pcs  |

# ASSEMBLY INSTRUCTIONS

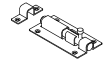
**1** Install the latch 12 to the front panel C and tighten them with screw 13. Tighten pin 1 and insert wooden dowel 3 into the top panel A, front panel C and back panel D.

			
<b>1</b>	<b>3</b>	<b>12</b>	<b>13</b>
x 16 pcs	x 8 pcs	x 2 sets	x 12 pcs

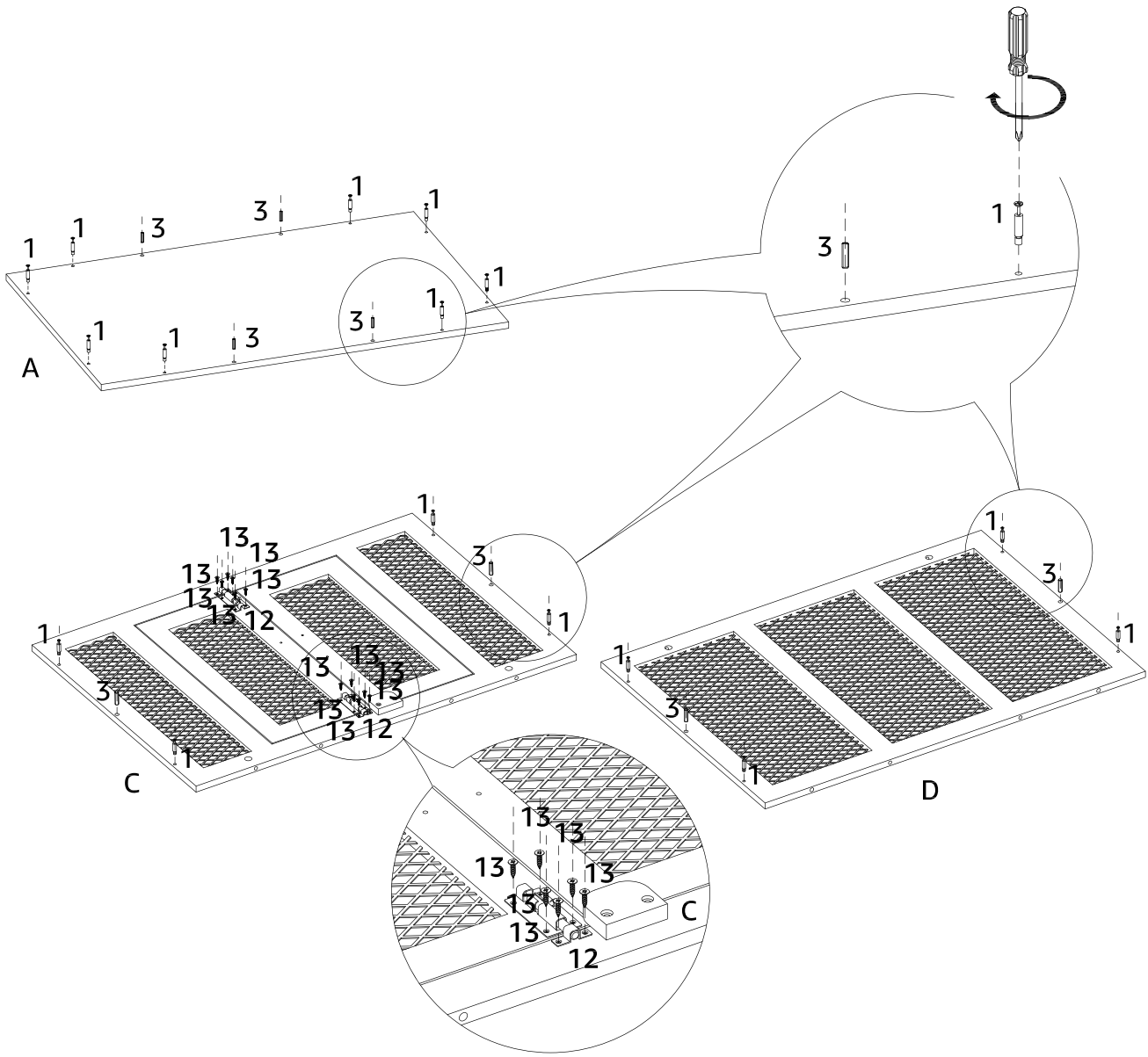

2

Connect left panel E with back panel D, insert cam lock 2 into the hole of left panel E, tighten cam lock 2 to pin 1.  
Connect right panel F with back panel D, insert cam lock 2 into the hole of right panel F, tighten cam lock 2 to pin 1.

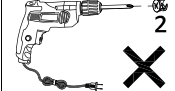
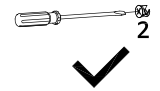
 2 x 4 pcs	 <b>NO!</b>	 <b>YES!</b>
--	---	--

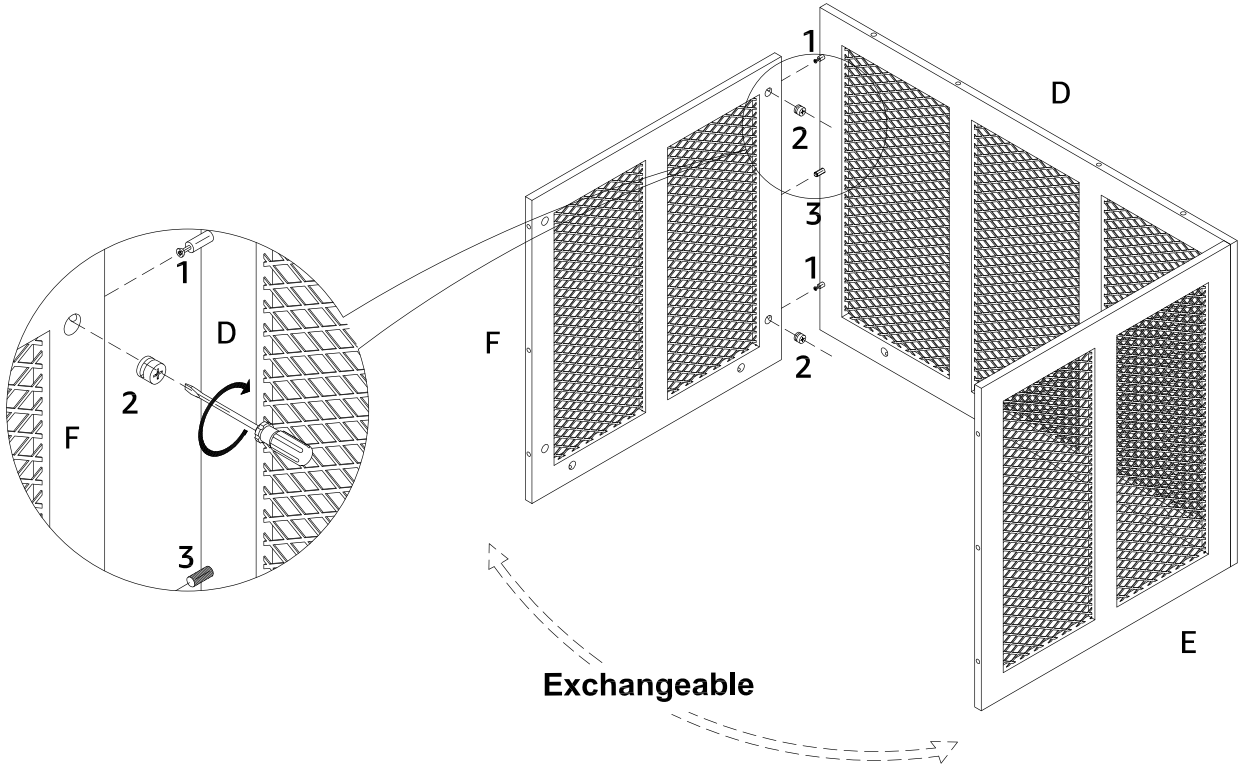
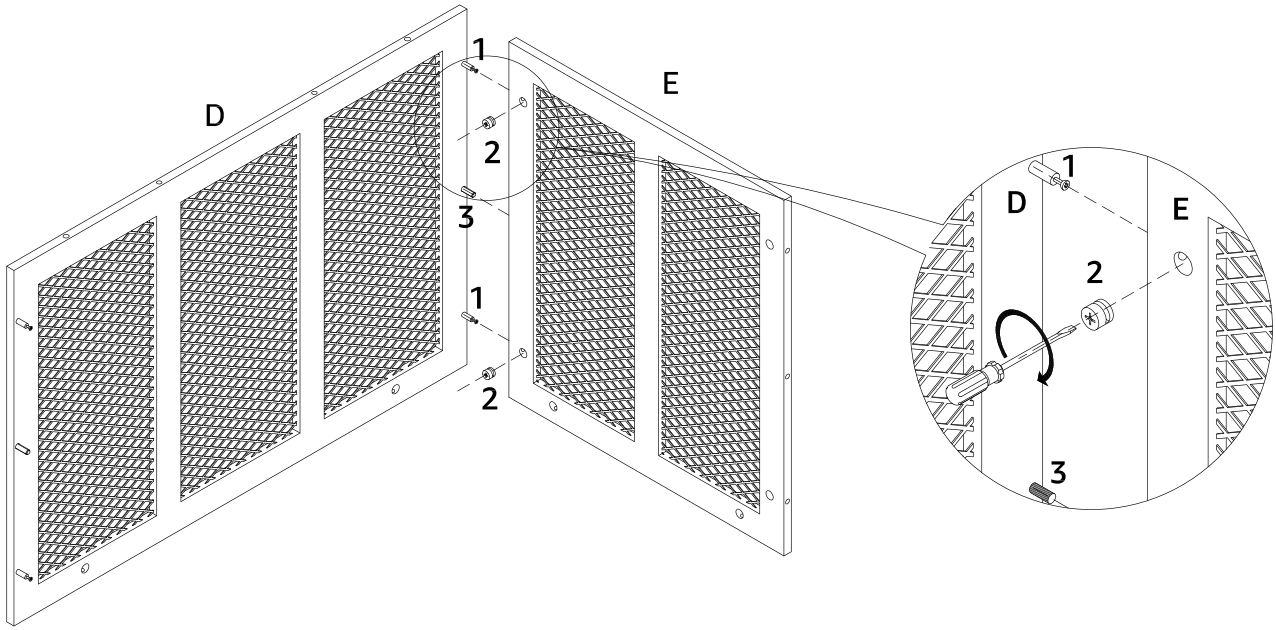

3



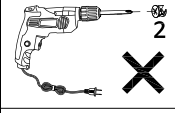
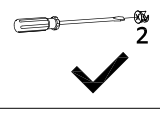

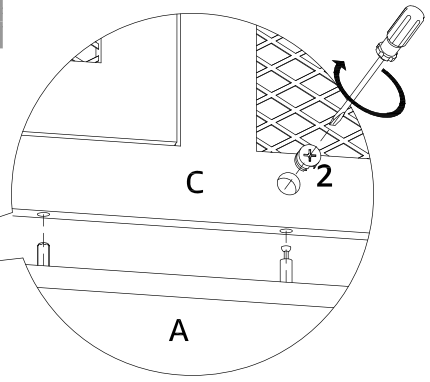
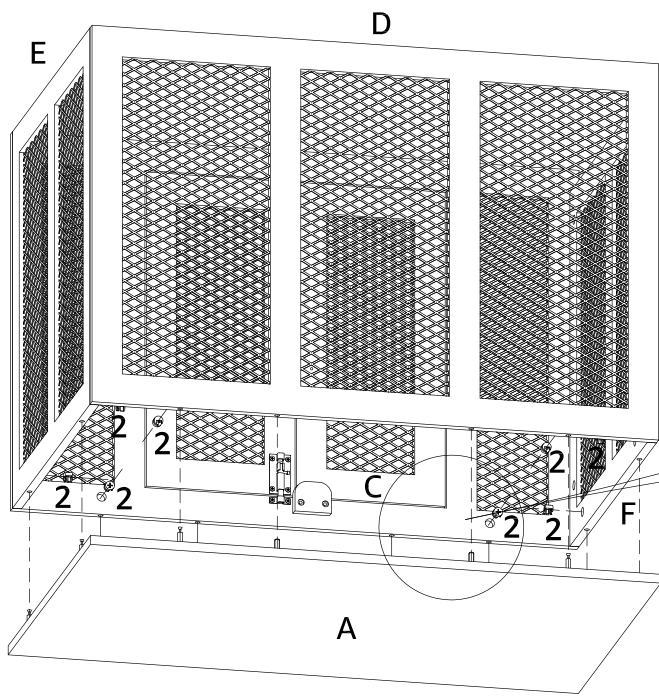
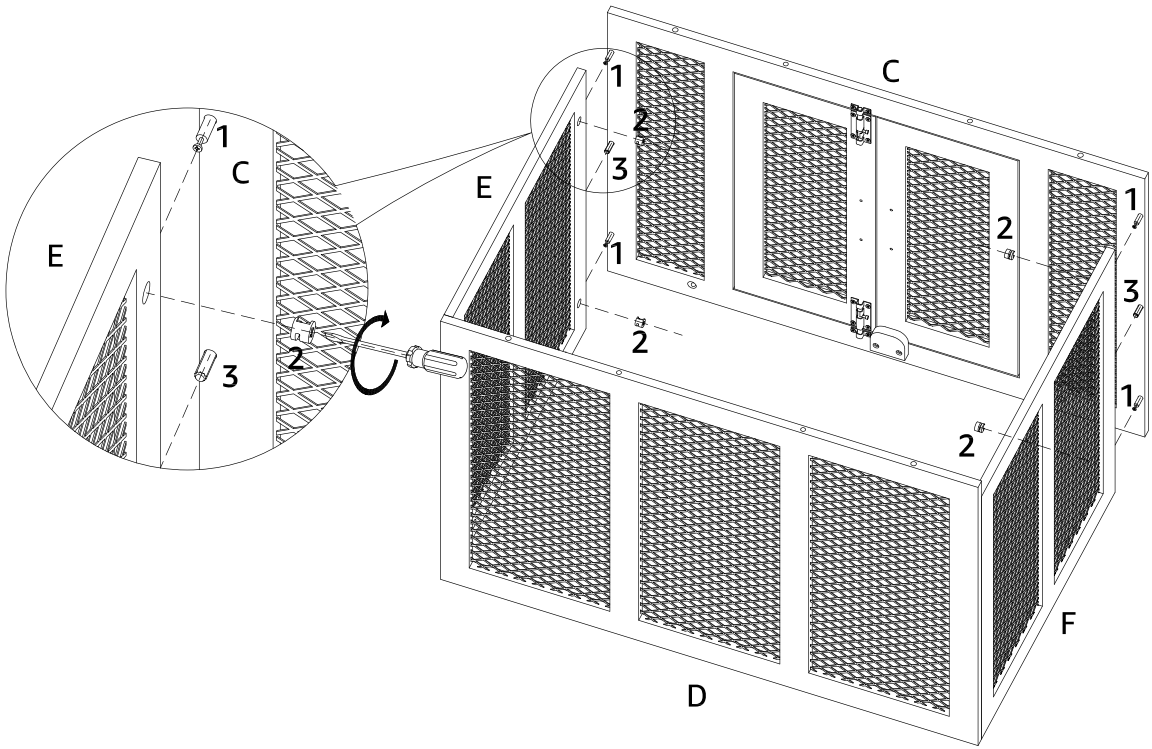

Connect front panel C with left panel E and right panel F, insert cam lock 2 into the hole of left panel E and right panel F, tighten cam lock 2 to pin 1. Input the body frame into the top panel A, insert cam lock 2 into the hole of the body frame, tighten cam lock 2 to pin 1.

 2 x 12 pcs	 NO!	 YES!
---	--	---





4

Insert wooden dowel 3 into front panel C and back panel D.  
Input bottom panel B to the body frame, tighten bolt 4 with washer 5 and 6 into the hole of bottom panel B by Allen Wrench 7.  
Turn upside down, tighten the handle 8 to the door on front panel C with screw 9.

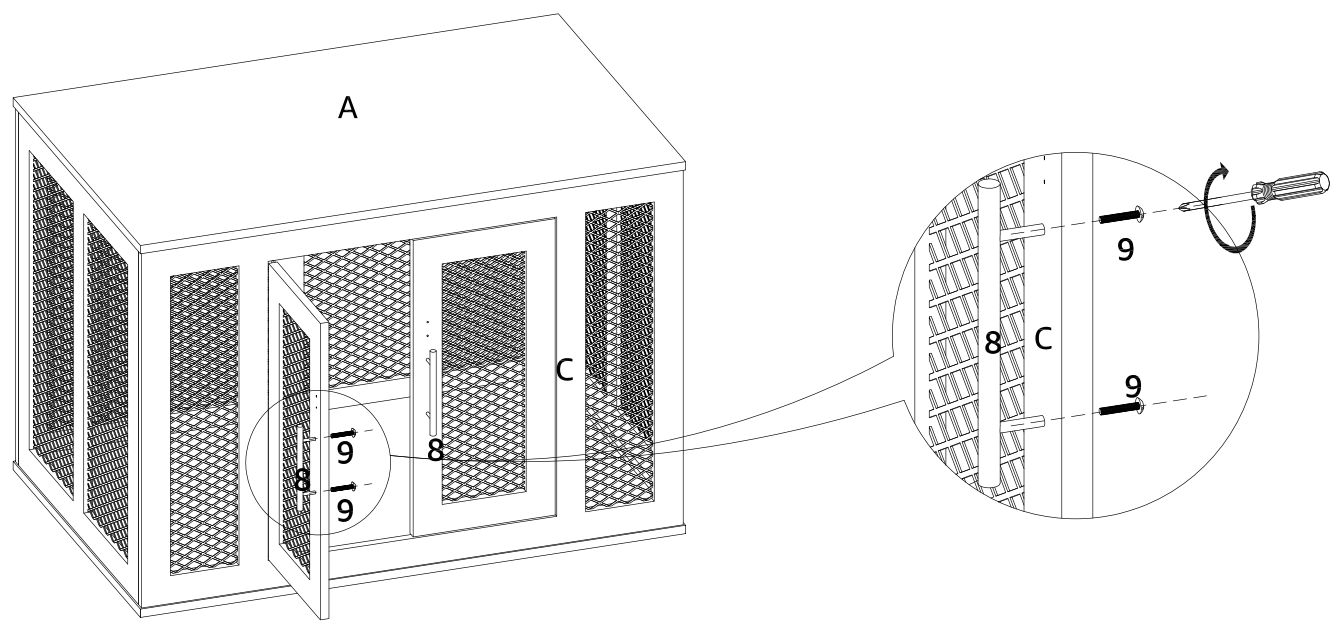
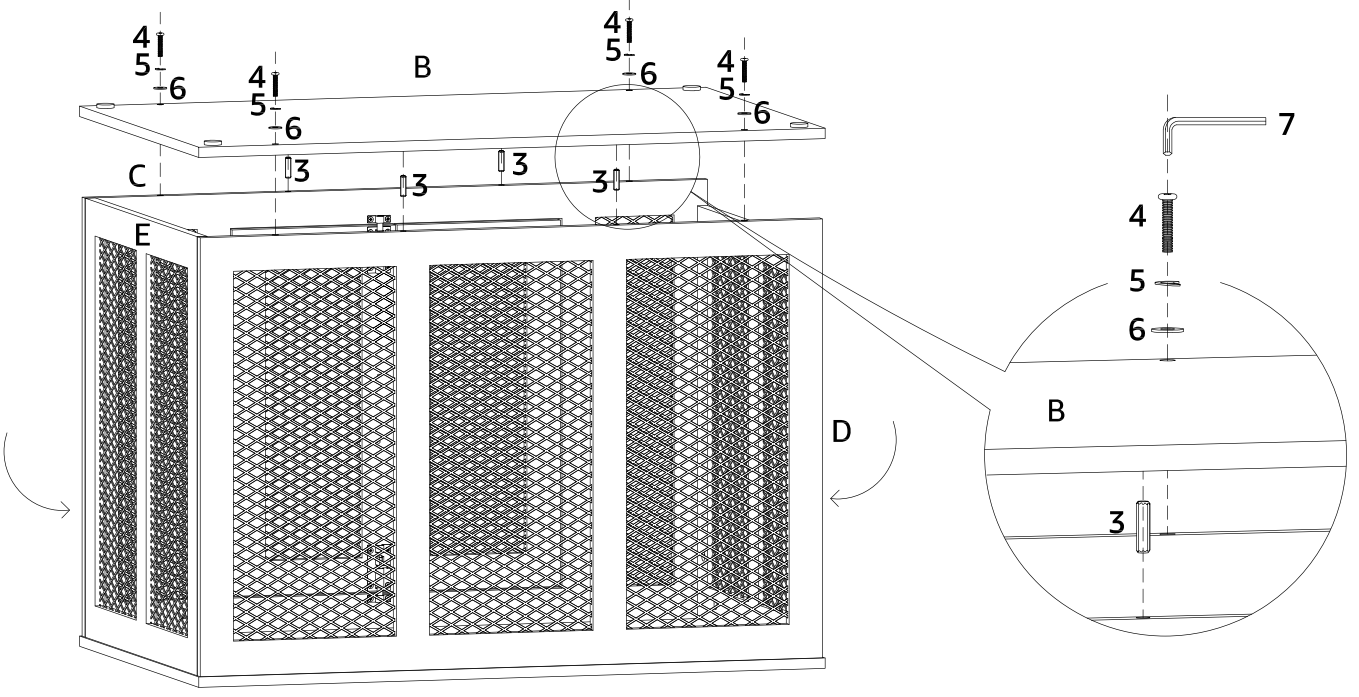
						
3 x 4 pcs	4 x 4 pcs	5 x 4 pcs	6 x 4 pcs	7 x 1 pc	8 x 2 pcs	9 x 4 pcs

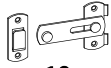

- 5** Install the locker 10 to the door on front panel C with screw 11.  
Insert plastic tray G to right panel F.

	
<b>10</b> x 1 set	<b>11</b> x 4 pcs

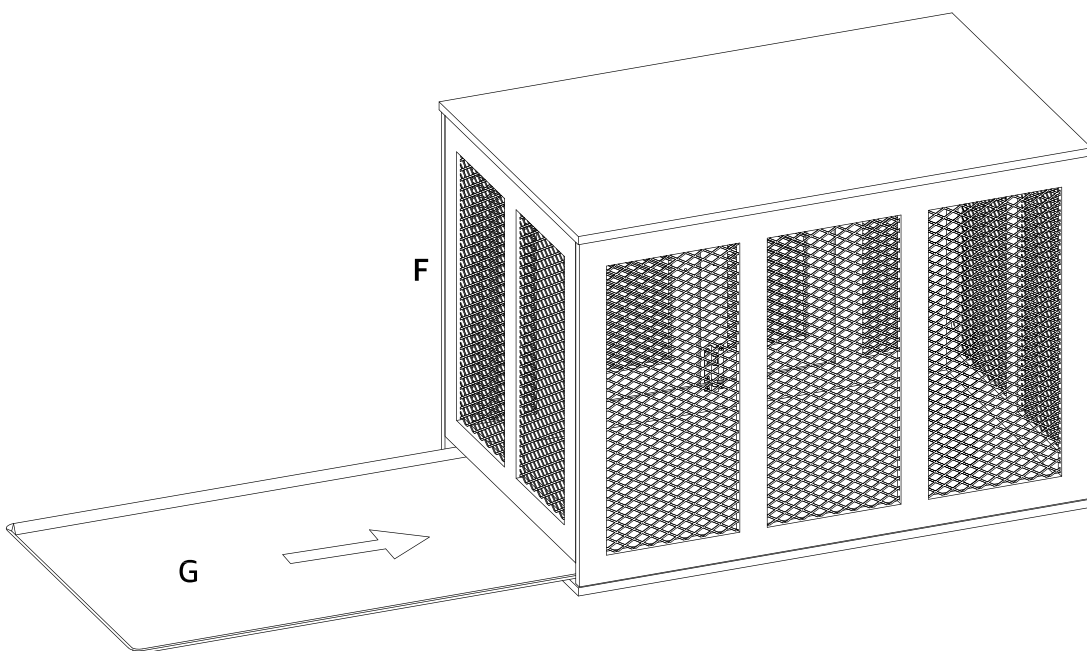
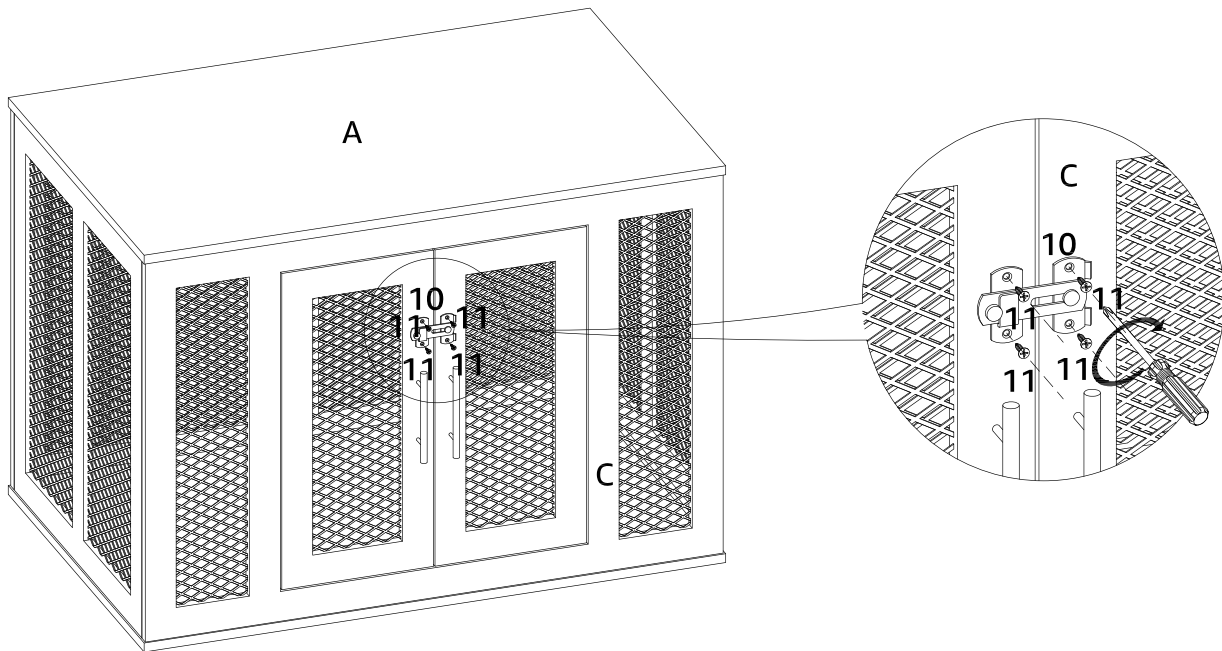



6 Input the cushion H into the crate.

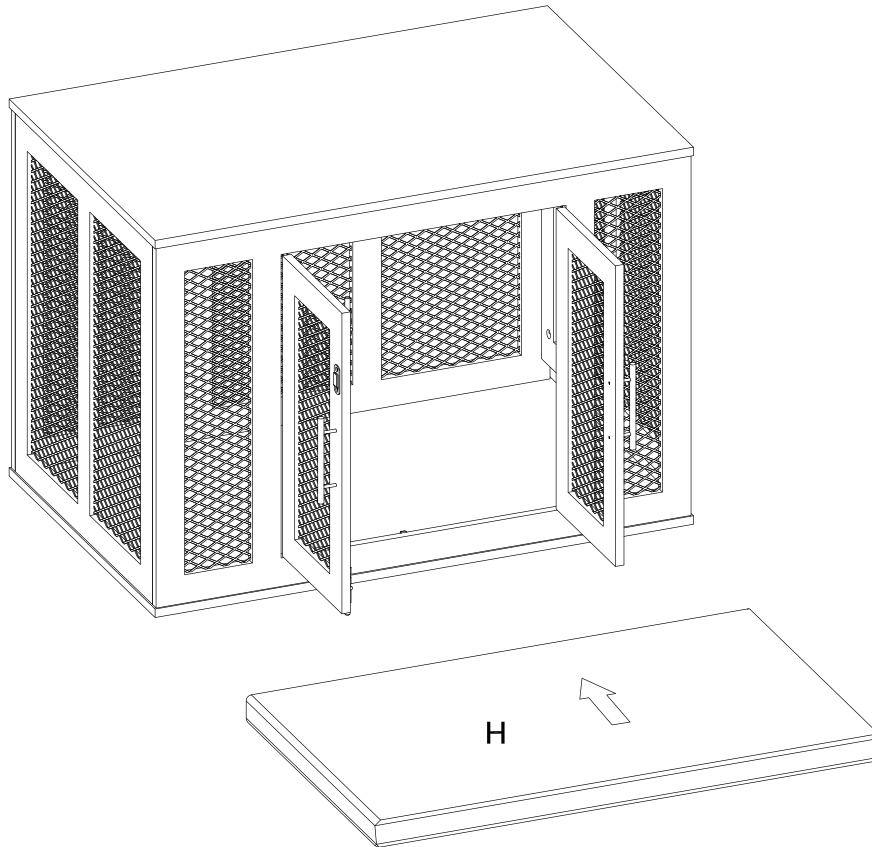

**!** Warning: Please lock the latch 12 when you close the door.

